



## Installation, Safety, Operation & Maintenance Instructions And Parts List For Models TAF, WAF, HTF & WAF/HTF, Belt Drive Tube Axial Fans Arrangement 9

**NOTE**  
READ ENTIRE MANUAL, INCLUDING "SECTION IV. INITIAL UNIT STARTUP" BEFORE ATTEMPTING TO INSTALL AND OPERATE THIS EQUIPMENT.

### FAN SPECIFICATIONS

**FAN SERIAL NUMBER:** \_\_\_\_\_ **MFG. DATE:** \_\_\_\_\_

**NOTE:** The serial number above is a required reference for any assistance. It is stamped on the fan nameplate.

**FAN SPECIFICATIONS:**

**Model:** \_\_\_\_\_ **Propeller Number:** \_\_\_\_\_

**FAN PERFORMANCE DATA:** (If entered on order)

**CFM:** \_\_\_\_\_ **SP:** \_\_\_\_\_ (Inches of Water Gauge) **Motor BHP:** \_\_\_\_\_

**Density:** \_\_\_\_\_ **Altitude:** \_\_\_\_\_ (Ft. above S.L.) **Airstream Temperature:** \_\_\_\_\_ °F.

**Fan RPM:** \_\_\_\_\_ **Maximum Safe Fan RPM:** \_\_\_\_\_ **DO NOT EXCEED THIS RPM**

**MOTOR DATA:** (This section is completed only if the motor was supplied by Cincinnati Fan)

**HP:** \_\_\_\_\_ **RPM:** \_\_\_\_\_ **Voltage:** \_\_\_\_\_ **Phase:** \_\_\_\_\_

**Hz:** \_\_\_\_\_ **Frame Size:** \_\_\_\_\_ **Enclosure:** \_\_\_\_\_ **Efficiency:** \_\_\_\_\_

**IF Motor is EXP, Class(es) & Group(s) are:** \_\_\_\_\_

**Manufacturers Model Number:** \_\_\_\_\_ **CFV Part Number:** \_\_\_\_\_

**DRIVE DATA:**

**Fan Sheave:** \_\_\_\_\_ **Motor Sheave:** \_\_\_\_\_ **Belts:** \_\_\_\_\_

**No. of Grooves:** \_\_\_\_\_ **Fixed Speed:**  **Adjustable Speed:**





### ATTENTION: RECEIVING DEPARTMENT

All Cincinnati Fan products are packaged to minimize any damage during shipment. The freight carrier is responsible for delivering all items in their original condition as received from Cincinnati Fan. The individual receiving this equipment is responsible for inspecting this unit for any obvious or concealed damage. If any damage is found, it should be noted on the bill of lading before the freight is accepted and the receiver must file a claim with the freight carrier.

### LONG TERM STORAGE NOTICE

If this fan will **NOT** be installed and put into operation within 30 days, refer to the "Long Term Storage Instructions" on page 15. Failure to follow all applicable long term storage instructions, will void your warranty. This fan should be stored indoors in a clean, dry location.

**⚠ DANGER**

				
Hazardous voltage can cause electrical shock and death.	High speed rotating equipment can cause severe personal injury.	Lock out/Tag out to prevent personal injury <u>BEFORE</u> starting <u>ANY</u> service or inspection.	Avoid injury. <u>NEVER</u> operate without <u>ALL</u> required safety guards in place.	Avoid injury. You <u>MUST</u> read and understand all instructions in this manual <u>BEFORE</u> installing.

**TABLE OF CONTENTS**

<p><b>I. GENERAL</b></p> <p style="padding-left: 20px;">A. Unpacking and Handling .....2</p> <p style="padding-left: 20px;">B. Safety Instructions &amp; Accessories .....2-3</p> <p><b>II. INSTALLATION</b></p> <p style="padding-left: 20px;">A. Vibration.....3</p> <p style="padding-left: 20px;">B. Mounting Methods .....4</p> <p style="padding-left: 20px;">C. Safety Guards.....4</p> <p style="padding-left: 20px;">D. Dampers and Shutters.....4</p> <p style="padding-left: 20px;">E. Set Screw and Taper-lock Bushing Torque Values .....4</p> <p style="padding-left: 20px;">F. Fan Bearings .....5</p> <p style="padding-left: 20px;">G. V-Belt Drives .....5</p> <p style="padding-left: 20px;">H. V-Belt Drive Installation .....5-6</p> <p><b>III. ELECTRICAL</b></p> <p style="padding-left: 20px;">A. Disconnect Switches.....6</p> <p style="padding-left: 20px;">B. Motors.....6-7</p> <p style="padding-left: 20px;">C. Maximum Speed &amp; Speed Controllers .....8</p>	<p><b>IV. INITIAL UNIT STARTUP</b></p> <p style="padding-left: 20px;">A. Pre-Startup &amp; Post-Startup Checks.....8</p> <p style="padding-left: 20px;">B. Vibration.....9</p> <p><b>V. ROUTINE INSPECTION &amp; MAINTENANCE</b></p> <p style="padding-left: 20px;">A. Hardware .....9</p> <p style="padding-left: 20px;">B. Motor or Fan Bearing Lubrication.....9-10</p> <p style="padding-left: 20px;">C. Propeller Balance .....10</p> <p style="padding-left: 20px;">D. Vibration.....11</p> <p style="padding-left: 20px;">E. Fan Shaft or Bearing Replacement.....11-12</p> <p style="padding-left: 20px;">F. Dampers and Shutters.....12</p> <p style="padding-left: 20px;">G. Safety Equipment or Accessories.....13</p> <p><b>VI. ORDERING REPLACEMENT PARTS</b> .....13</p> <p><b>VII. TROUBLESHOOTING</b> .....14</p> <p><b>VIII. LONG TERM STORAGE</b> .....15</p> <p><b>IX. WARRANTY, LIMITS OF LIABILITY, RESPONSIBILITY &amp; RETURNS</b>.....16</p> <p><b>X. PARTS DRAWING</b>.....17</p>
---	--

**I. GENERAL**

**A. Unpacking:**

Be careful not to damage or deform any parts of the fan when removing it from the packaging container. **All the packaging material should be kept in the event the fan needs to be returned.**

**Handling:**

Handling of the fan should be performed by trained personnel and be consistent with all safe handling practices. Verify that all lifting equipment is in good operating condition and has the proper lifting capacity. The fan should be lifted using well-padded chains, cables or lifting straps with spreader bars. **NEVER lift the fan by an inlet or discharge flange, fan or motor shaft, motor eye bolt, or any other part of the fan assembly that could cause distortion of the fan assembly.**

**B. Safety Instructions & Accessories:**

**1. Safety Instructions:**

All installers, operators and maintenance personnel should read AMCA Publication 410-96, “**Recommended Safety Practices for Users and Installers of Industrial and Commercial Fans**”. This manual is included with the fan. Additional copies can be requested by writing us at Cincinnati Fan, 7697 Snider Rd., Mason, OH 45040-9135

**2. Sound:**

Some fans can generate sound that could be hazardous to personnel. It is the responsibility of the user to measure the sound levels of the fan and/or system, determine the degree of personnel exposure, and comply with all applicable safety laws and requirements to protect personnel from excessive noise.

### 3. Air Pressure and Suction:

In addition to the normal dangers of rotating machinery, the fan can present additional hazards from the suction or pressure created at the fan inlet or discharge. Suction at the fan inlet can draw materials into the fan where they become high velocity projectiles at the discharge and cause severe personal injury or death. It can also be extremely dangerous to persons in close proximity to the inlet or discharge as the forces involved can overcome the strength of most individuals.

#### WARNING

**NEVER OPERATE A FAN WITH A NON-DUCTED INLET AND/OR DISCHARGE. IF THE FAN INLET AND/OR DISCHARGE IS NON-DUCTED, IT IS THE USERS RESPONSIBILITY TO INSTALL AN INLET AND/OR DISCHARGE GUARD.**

### 4. Temperature:

Many fans, fan components and all motors operate at temperatures that could burn someone if they come in contact with them. If this potential hazard could exist in your installation, steps must be taken by the user to protect anyone from coming in contact with this equipment. The maximum airstream temperature for this fan is:

Fan Models	Max. Airstream Temperature
TAF & WAF	200°F (93°C)
HTF & WAF/HTF	375°F (191°C)

### 5. Spark Resistance: (Per AMCA Standard 99-0401-86 and ISO 13499)

#### DANGER

**NO GUARANTEE OF ANY LEVEL OF SPARK RESISTANCE IS IMPLIED BY SPARK RESISTANT CONSTRUCTION. IT HAS BEEN DEMONSTRATED THAT ALUMINUM IMPELLERS RUBBING ON RUSTY STEEL CAN CAUSE HIGH INTENSITY SPARKS. AIR STREAM MATERIAL AND DEBRIS OR OTHER SYSTEM FACTORS CAN ALSO CAUSE SPARKS.**

### 6. Safety Accessories:

#### Guards:

All moving parts must be guarded to protect personnel. Safety requirements can vary, so the number and types of guards required to meet company, local, state and OSHA regulations must be determined and specified by the actual user or operator of the equipment.

**NEVER start any fan without having all required safety guards properly installed. All fans should be checked on a regular schedule, for missing or damaged guards. If any required guards are found to be missing or defective, the power to the fan should be immediately turned off and locked out in accordance with OSHA regulations. Power to the fan should NOT be turned back on until the required guards have been repaired or replaced.**

This fan can become dangerous due to a potential “windmill” effect, even though all electrical power has been turned off or disconnected. The fan propeller should be **carefully** secured to prevent any rotational turning **BEFORE** working on any parts of the fan/motor assembly that could move.

### 7. Access or Inspection Doors:

#### DANGER

**NEVER OPEN ANY ACCESS OR INSPECTION DOORS WHILE THE FAN IS OPERATING. SERIOUS INJURY OR DEATH COULD RESULT FROM THE EFFECTS OF AIR PRESSURE OR AIR SUCTION. DISCONNECT OR LOCK OUT POWER TO THE FAN AND LET THE FAN PROPELLER COME TO A COMPLETE STOP BEFORE OPENING ANY TYPE OF ACCESS OR INSPECTION DOOR.**

## II. INSTALLATION

### A. Vibration:

Before any mounting method is selected, the user should be aware of the effects vibration will have on the fan, motor and other parts. Improper fan installation can cause excessive vibration causing premature prop and/or bearing failure, that is not covered under warranty. Vibration eliminator pads or springs should be properly installed to prevent any fan vibration from transmitting to the foundation or support structure.

#### WARNING

**SHUT THE FAN DOWN IMMEDIATELY IF THERE IS ANY SUDDEN INCREASE IN VIBRATION.**

## B. Mounting Methods:

### 1. In Duct Work

Any component of a building structure that will be supporting the fan and any duct work must have the weight load capacity and be rigid enough to support the weight of the fan without bending, bowing or flexing during operation. If not, severe vibration can occur that could lead to fan and/or structural failure. Consult an architectural or structural engineer for assistance.

**Tube axial** fans are designed to be mounted in duct work of the same diameter as the fan. The flange rings are pre-punched and should be bolted to duct flanges having the same dimensions. We do offer companion rings, as an option, to make the connection process easier. These fans can be mounted with the fan and motor shaft in a horizontal or vertical up-blast (motor shaft down) configuration.

### DANGER

**If this fan will be mounted in a vertical down-blast configuration, with the motor shaft up, the propeller MUST be secured to the fan shaft with a pin or locking collar. If there is no pin or locking collar to additionally secure the propeller to the fan shaft, DO NOT use the fan without adding this feature. Not providing this feature could lead to property damage, injury or death.**

The use of flexible connectors on the inlet and outlet of the fan will make it possible to mount this fan in a duct system and isolate any fan/motor vibration from the duct work. If flexible connectors will be used, the fan should be equipped with horizontal or vertical support clips. Threaded rod should be used to connect the support clips to the building structure. Each rod should be strong enough to support two (2) times the weight of the entire fan/motor assembly. Spring hangers would be needed on the rods to isolate any fan vibration from the building.

### 2. On Machinery

If this fan will be mounted on machinery, the surface it will be mounted to must be strong and rigid enough to support the weight of the entire fan without flexing, bowing, bending or oil-canning and thus causing vibration. Companion rings are available that will match the flanges on this fan. To minimize any leakage, it is recommended that some type of caulking be used between the fan flange and the machine.

## C. Safety Guards:

Cincinnati Fan offers guards, as optional, to keep your fan in compliance with OSHA safety regulations. These include inlet or discharge guards and belt guards. It is the responsibility of the user to make sure this fan meets all local, state and OSHA safety regulations. If you have a specific guard requirement not covered by OSHA, please contact the local Cincinnati Fan sales office for assistance.

## D. Dampers and Shutters: (Airflow control devices)

If the fan is supplied with any type of air flow control device, it should be closed before initial startup of the fan to minimize overloading of the motor. Any airflow control device, with bearings, should be maintained in accordance with the manufacturers instructions. Any air flow control device, with an automatic control mechanism, should be adjusted per the manufacturers recommendations.

## E. Set Screw and Taper-lock Bushing Torque Values:

All propeller set screws are tightened to the proper torque prior to shipment. Some props may have taper-lock hubs and split, taper-lock bushings to secure the prop to the fan shaft.

**NOTE:** Check all set screw or taper-lock bushing torques. Forces encountered during shipment, handling, rigging and temperature can affect factory settings. For correct torque values, see **Tables 1** and **2** below.

Table 1

SET SCREW TORQUE VALUES		
Diameter & Number of Treads/Inch	Hex Wrence Size (Across Flats)	Required Torque (Inch Pounds)
1/4-20	1/8"	65
5/16-18	5/32"	165
3/8-16	3/16"	228
7/16-14	7/32"	348
1/2-13	1/4"	504
5/8-11	5/16"	1104

Table 2

TORQUE VALUES FOR TAPER-LOCK BUSHINGS	
Taper-lock Bushing Size	Required Torque (Inch Pounds)
H	95
B	192
P	192
Q	350
R	350

### CAUTION

Set screws should **NEVER** be used more than once. If the set screws are loosened, they **MUST** be replaced. Use only knurled, cup-point, set screws with a nylon locking patch.

## F. Fan Bearings:

If the fan bearings have set screws to lock the bearings onto the fan shaft, the set screws should be tightened to the same torque levels as shown in **Table 1** on page 4. Fan bearings should be lubricated in accordance with the bearing manufacturer's recommendation and with the same type of grease. **See chart under Section B-2 on page 11. The fan bearings are pre-lubricated at the factory. The fan bearing cover should only be removed during inspection or maintenance, but only after the power to the motor has been turned off and locked out.** The bearing cover **MUST** be replaced before the power is turned back on.

## G.V-Belt Drives:

If Cincinnati Fan supplied the belts and sheaves (drives package), they were carefully selected for the specific operating conditions supplied to us by the customer.

### **⚠ DANGER**

**Changing any of the v-belt drive component selections, supplied with the fan, could result in unsafe operating conditions which could cause equipment failure, personal injury and death.**

If the user is supplying the sheaves and/or belts, it is their responsibility to make the correct component selections for the specific operating conditions. Their selection must also **NOT ALLOW** the fan to exceed its **maximum safe speed or hub load**. If you do not know the maximum safe speed or hub load for this fan, **DO NOT** make any drive selection without first consulting Cincinnati Fan or our sales office for your area. **"Timing" belts should never be used on fans.** If you are replacing belts and/or sheaves, checking belt tension or proper alignment, **see below and page 6**. Sheave set screws or taper-lock bushing bolts should be tightened to the torque values as indicated in **Tables 1 and/or 2** on page 4.

## H. V-Belt Drive Installation:

**Power to the motor must be turned off and locked out, BEFORE inspecting, installing or servicing any components of the drives. READ AND FOLLOW ALL THE STEPS BELOW AND ON PAGE 6.**

If you are installing any new belts, inspect and replace any worn or damaged sheaves, bearings or shafts while the power is **turned off and locked out**. This will eliminate additional down time later to replace any other parts that were worn or defective.

If you are installing a complete set of new drives, the most critical steps of the installation are alignment of the sheaves and belt tension. **Misaligned sheaves and/or improper belt tension will cause excessive fan vibration and result in premature belt and /or bearing failure.**

The fan and motor shafts must be parallel and the sheaves must be in line with each other. See **Fig. 1** at right.

**Fig. 1**

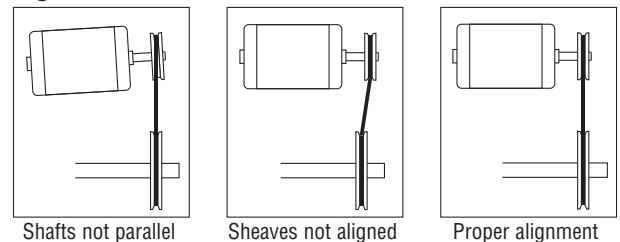

For complete drive installation instructions, please see these websites:

[www.emerson-ept.com/catalogs/instshts/browning/form5453.pdf](http://www.emerson-ept.com/catalogs/instshts/browning/form5453.pdf)  
**OR**

[www.maskapulleys.com/images/produit/Product%20Training\\_jan09.1.pdf](http://www.maskapulleys.com/images/produit/Product%20Training_jan09.1.pdf)

## **ASSEMBLY STEPS:** (Below are general instructions. Obtain specific instructions from your drives dealer)

### **NOTE:** The fan must be removed from the duct work or machine to install or replace the drives

1. Lockout and disconnect power to the motor.
2. Remove belt guard or belt guard/weather cover, if supplied.
3. Remove the screws that hold the bearing cover to the bearing base. Remove the cover.
4. The adjustable motor base should be used for belt tension adjustment. Loosen the tension on the belts by first loosening the 4 "**locking bolts**" in the side of the base, but **DO NOT** remove these bolts.
5. Turn the 4 "**tensioning bolts**" in the top of the motor base counter-clockwise, so the motor base moves as close to the fan drum as possible. This will reduce the tension on the belts.
6. Remove belt(s) from the motor sheave and then the fan sheave. Remove belt(s) from through the belt tube.  
**If replacing belts and sheaves, go on to Step 7. If replacing belts only, go to Step 12** on page 6.
7. Loosen set screws or taper-lock bolts in the fan sheave and the motor sheave. Remove sheaves.
8. Check the fan and motor shafts for any nicks or burrs. Remove any burrs with a file or emery paper.
9. Slide new sheaves onto the fan and motor shafts. **DO NOT** drive or pound the sheaves on as this may damage the fan and/or motor bearings.
10. Align the fan and motor sheaves with a straight-edge (or string) as shown in **Fig. 2** on page 6. If the sheaves are not the same width, align by sight. For more precise methods, consult your local drives dealer.

**NOTE:** Any sheave with a taper-lock bushing will slide a little on the shaft as the bolts are tightened. You will need to compensate for the sliding before performing **Step 12** on page 6.

**If you are also replacing the motor, you might need to adjust the motor on the motor base to keep the fan and motor shafts parallel as shown in Fig. 1** above.

11. Slide the belt(s) into the belt tube and place the belt(s) over the sheaves. **DO NOT** force, pry or “roll” the belts, as this could damage the cords in the belt(s). If there is more than 1 belt, all the belts should be a “matched set”.
12. After the sheaves are properly aligned and parallel, tighten the set screws and/or taper-lock hub bolts in the sheaves to the correct torque values shown in **Tables 1** and/or **2** on page 4.
13. Adjust the motor base, by turning the 4 “**tensioning bolts**” in the top of the base clockwise, until the belts appear to be snug, then recheck the alignment as in **Step 10** on page 5.
14. Finger tighten the “**locking bolts**” in the side of the base.  
**WARNING: BEFORE ATTEMPTING THE FOLLOWING STEPS, MAKE SURE THE AREA AROUND THE FAN IS SAFE AND SECURED SO NO ONE CAN GET NEAR THE FAN AND GET INJURED WHEN IT IS STARTED. USE CAUTION AND GOOD JUDGMENT.**
15. Reconnect or unlock power to the motor and run the fan for a few minutes to allow belts to “seat” properly. **Then turn off and lock out the power to the motor.**
16. Loosen the 4 “**locking bolts**”, in the side of the motor base, and re-adjust the belt tension using the 4 “**tensioning bolts**” in the top of the base.
17. Tighten the 4 “**locking bolts**” in the side of the motor base.
18. Unlock power to motor and run the fan. The belts should be running as shown in **Fig. 3** below. If not, repeat **Steps 10-14** above **after you have turned off power to the motor.**
19. **Disconnect power to the motor.**
20. Reinstall the bearing cover and any safety guards.
21. Reinstall fan into the duct system or machine.
22. Reconnect power to the motor and turn on.
23. After running the fan for 3 days, **lock out and disconnect power to the motor** and remove fan from the duct system or machine.
24. Connect power to the motor and repeat **Step 18** above.
25. Repeat any other steps as necessary.

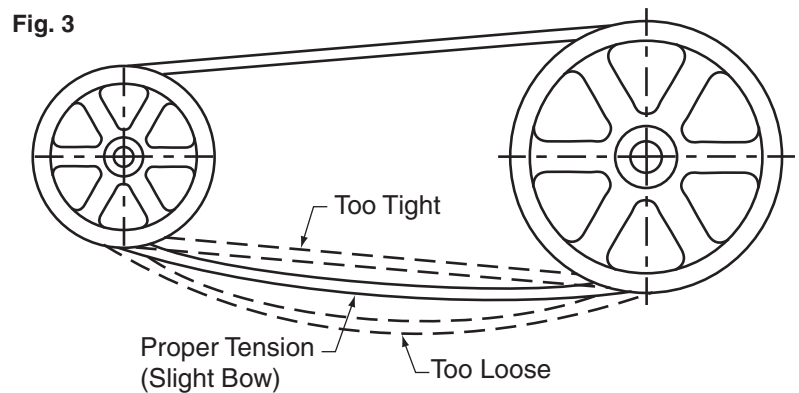
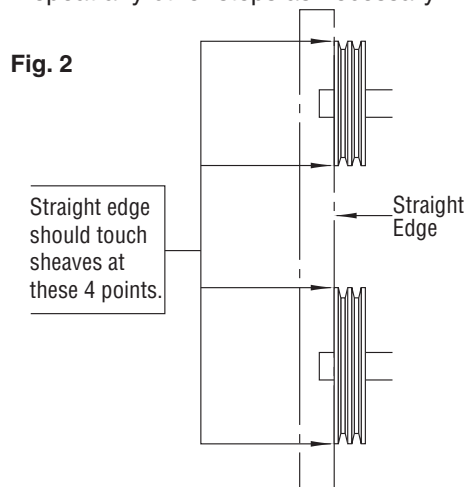

### III. ELECTRICAL

#### A. Disconnect Switches:

All fan motors should have an independent disconnect switch located in close visual proximity to turn off the electrical service to the fan motor. **Disconnects must be locked out in accordance with OSHA “lock out-tag out” procedures before any inspection or maintenance is performed on the fan and/or motor assembly. The “lock out-tag out” procedure should be performed by a licensed electrician or authorized personnel.**

All disconnects should be sized in accordance with the latest NEC codes (National Electric Codes) and any local codes and should be installed only by a licensed electrician. “Slow blow” or “time delay” fuses or breakers should be used since the initial start-up time for the fan motor, although rare, can be up to 10 seconds.

#### B. Motors:

### ⚠ DANGER

**ALL WIRING CONNECTIONS, INSPECTION AND MAINTENANCE OF ANY MOTOR MUST BE PERFORMED BY A LICENSED ELECTRICIAN IN ACCORDANCE WITH THE MOTOR MANUFACTURERS RECOMMENDATIONS, ALL ELECTRICAL CODES AND OSHA REGULATIONS. FAILURE TO PROPERLY INSTALL, MAKE WIRING CONNECTIONS, INSPECT OR PERFORM ANY MAINTENANCE TO A MOTOR CAN RESULT IN MOTOR FAILURE, PROPERTY DAMAGE, EXPLOSION, ELECTRICAL SHOCK AND DEATH.**

1. **DO NOT** connect or operate a motor without reading the motor manufacturers instructions supplied with the fan. The basic principle of motor maintenance is: **KEEP THE MOTOR CLEAN AND DRY.** This requires periodic inspections of the motor. The frequency of the inspections depends on the type of motor, the service and environment it will be subjected to and the motor manufacturers instructions.

2. **Cleaning:** Cleaning should be limited to exterior surfaces only. **Follow motor manufacturers cleaning instructions.**
3. **Lubrication:** Most small motors have sealed bearings that are permanently lubricated for the life of the motor. Some larger motors have grease plugs that should be replaced with grease fittings to perform re-lubrication. These motors, or any motor with grease fittings, should be lubricated in accordance with the motor manufacturers recommendations. Lubrication frequency depends on the motor horsepower, speed and service. **BE SURE** you use compatible grease and **DO NOT** over grease.
4. **Location:** A standard Open Drip Proof or Totally Enclosed type motor is suitable in a clean, dry location below 104°F. (40°C). If the location will be wet, dirty or reach temperatures above 104°F (40°C), a different type of motor may be necessary. Consult our local sales office for your area for proper motor selection assistance. All wiring must meet NEC (National Electric Codes) standards.
5. **Wiring Connections:** All wiring connections should be made for the proper voltage and phase as shown on the motor nameplate. Connections should follow the motor manufacturers recommendations as shown on the wiring schematic. This wiring diagram will be located on the outside of the motor, inside of the motor conduit box or on the motor nameplate. **Reversing some wires might be necessary to get the correct fan rotation.**
6. **Motors with Thermal Overload Protection:** If a motor is equipped with thermal overloads, the thermal overload must be wired per the wiring schematic to be operable. **There are 3 types of thermal overloads:**
  - a. **Automatic:** These will automatically shut the motor down if the internal temperature exceeds the design limits.

 **DANGER**

**MAKE SURE YOU LOCK OUT THE POWER TO THE MOTOR BEFORE INSPECTING ANY MOTOR WITH AUTOMATIC THERMALS. WHEN THE THERMALS COOL DOWN, THEY WILL ALLOW THE MOTOR TO AUTOMATICALLY START UP AGAIN, UNLESS YOU HAVE LOCKED OUT THE POWER TO THE MOTOR.**

- b. **Manual:** These motors will have a button on them. If the motor overheats, it will shut down. After you have inspected the motor and eliminated the over heating problem, you will need to “reset” it by pushing the button. **You should still lock out the power BEFORE inspecting the motor.**
  - c. **Thermostats:** This type of thermal is a temperature sensing device **ONLY**. If the motor overheats, the thermostats will open or close (depending on the type) and send a “**signal**” to the electrical box. **THEY WILL NOT TURN THE MOTOR OFF.** These are pilot circuit devices that must be connected to the magnetic starter circuit.
7. **EXPLOSION PROOF Motors:** No motor is explosion proof. Explosion proof (EXP) motors are designed so if there is an explosion **WITHIN** the motor, the explosion will be **CONTAINED INSIDE** the motor and not allowed to get out to the atmosphere. All explosion proof motors must be selected based on the atmosphere and/or the environment the motor will be operating in. Explosion proof motors are designed, rated, and labeled for their operating conditions based on Classes, Groups and “T” Codes. **The Class, Group and “T” Code of an EXP motor MUST be selected based on the atmosphere and/or environmental conditions the motor will be operating in. Consult the NEC (National Electric Code) and the NFPA (National Fire Protection Association) for the proper EXP motor Class, Group and “T” Code required for your specific application and location.**

 **DANGER**

**IF AN EXPLOSION PROOF MOTOR IS USED IN AN AREA CONTAINING VOLATILE LIQUIDS, GASES, FUMES OR DUST FOR WHICH THE MOTOR WAS NOT DESIGNED TO OPERATE IN, AN EXPLOSION AND/OR FIRE CAN OCCUR.**

**NOTICE:**

- a. All EXP motors have some type of thermal overload as required by UL (Underwriters Laboratories). Refer to all of Section 6 above.
  - b. All EXP motors are required to have the UL (Underwriters Laboratories) and CSA (Canadian Standards Association) listing numbers on the motor name plate or on a separate plate attached to the motor. The Class, Group and “T” Code the motor is designed for must also be listed.
8. **Normal Motor Operating Temperatures:**  
Using your hand to test the normal running temperature of a motor can be a very painful experience;  
**The normal operating temperature of a fully loaded, open type, electric motor operating in a 70°F. (21° C.) ambient temperature is 174°F. (79° C.)**

### C. Maximum Fan Speed and Motor Speed Controllers:

If you will be using any type of motor speed controller with this fan, **DO NOT** exceed the **maximum safe fan speed**. Installing and using a speed control device requires special training and certification as required by the speed control manufacturer. See the manufacturers instructions for proper use, installation and wiring connections for the maximum speed settings. It may also be necessary to “block out” some speeds to eliminate a resonant vibration problem. The maximum safe fan speed is shown on the data sheet shipped with the fan. If you have lost the data sheet, contact Cincinnati Fan or our sales office for your area. You must have the serial number from the **fan** name plate for us to determine the maximum safe fan speed. Cincinnati Fan will only extend the motor manufacturers warranty, when used with a speed controlling device, if the motor has the words “**Inverter Duty**” marked on the motor name plate. If the motor does not have “**Inverter Duty**” marked on the motor name plate, and you have a motor failure, you will be required to contact the motor manufacturer for any service or warranty claims.

## IV. INITIAL UNIT STARTUP

**NOTICE: Failure to complete and document all the following pre-startup and both post-startup checks, listed in sections A (below) and B on page 9, could void all warranties.**

### A. Pre-Startup & Post-Startup Checks: (Check blocks as each step is completed. Retain this for your records.)

A1. Pre-Startup Checks Completed By: \_\_\_\_\_ DATE: \_\_\_\_\_  
A2. 8 Hour, Post-Startup Checks Completed By: \_\_\_\_\_ DATE: \_\_\_\_\_  
A3. 3 Day, Post-Startup Checks Completed By: \_\_\_\_\_ DATE: \_\_\_\_\_

**MAKE SURE POWER TO THE MOTOR IS LOCKED OUT BEFORE STARTING PRE-STARTUP OR POST-STARTUP CHECKS.**

#### **BEFORE MOUNTING FAN IN DUCT WORK OR ON A MACHINE:**

If you will be mounting this fan into a duct system, and there is no access door in the fan drum, it is strongly recommended that an access door be installed in the duct work section next to the fan. That will allow you access to perform the post-startup checks more easily.

1.    Check the propeller by spinning it by hand to ensure it rotates freely.
2.    Check the propeller set screws to make sure they are tight per **Table 1** on page 4.
3.    If the propeller has a taper-lock bushing, make sure the bolts are tightened per **Table 2** on page 4.
4.    Make certain there is no foreign material in the fan or duct work that can become a projectile.
5.    Ensure all electrical power components are properly sized and matched for your electrical system.
6.    Record the Full Load Amps listed on the motor nameplate. You will need to refer to this later.

Low Voltage: \_\_\_\_\_

High Voltage: \_\_\_\_\_

#### **AFTER MOUNTING FAN IN DUCT WORK OR ON A MACHINE:**

7.    Check all duct work hardware to make sure it is tight.
8.    Make sure any inspection doors in the duct work are securely bolted or locked.
9.    Check that any required guards are properly secured.
10.    Any dampers or valves should be fully opened and closed to make sure there is no binding or interference.
11.    If your fan is mounted on an elevated support structure, make sure the structure is welded at all the joint connections and the structure is properly braced to prevent any “side sway”.
12.    Make sure the propeller is stationary prior to startup. **Starting a fan with a prop that is rotating backwards can cause propeller damage.**
13.    Make the necessary wiring connections to the motor per National Electric Code (NEC) regulations.
14.    Apply power to the fan motor momentarily (i.e. “bump start”) to check the propeller rotation. If the fan is rotating in the wrong direction, reconnect the motor leads per the motor manufacturers wiring schematic. **The fan rotation must match the rotation indicated by the rotation arrow decals on the outside of the fan drum.** After reconnecting the leads, repeat this step.
15.    Apply power to the fan motor and let it come up to full speed. **Turn off the power.** Listen for any unusual noise or mechanical abnormality while the propeller is still spinning. If any are noticed, lock out the power, wait for the propeller to come to a complete stop, locate the cause and correct it.
16.    Unlock power and start the fan.
17.    Measure, record and keep the following motor data for future reference and comparison.

**(Single phase motors will only have L1 and L2 leads.)**

**Amperage draw on each motor lead: L1 \_\_\_\_\_ L2 \_\_\_\_\_ L3 \_\_\_\_\_**

(Running amps **SHOULD NOT** exceed the motor nameplate amps for the voltage being operated on). **Compare these amp readings to the Full Load Amps you recorded in Step 6 above.**

**Voltage coming to motor leads: L1 \_\_\_\_\_ L2 \_\_\_\_\_ L3 \_\_\_\_\_**

(Should be about the same input voltage on all leads).



## B. Vibration:

All props are balanced to comply with ANSI S2.19, G6.3. However, rough handling in shipment and/or erection, weak and/or non-rigid foundations, and misalignment may cause a vibration problem after installation. After installation, the vibration levels should be checked by personnel experienced with vibration analysis and vibration analysis equipment.

## V. ROUTINE INSPECTION & MAINTENANCE

Periodic inspection of all the fan parts is the key to good maintenance and trouble-free operation. The frequency of inspections must be determined by the user and is dependent upon the severity of the application. **BUT**, it should **NEVER** exceed a 12 month period. The user should prepare an inspection and maintenance schedule and make sure it is adhered to.

### WARNING

**BEFORE STARTING ANY INSPECTION OR MAINTENANCE, BE SURE FAN IS TURNED OFF, POWER IS LOCKED OUT AND THE PROPELLER HAS BEEN CAREFULLY SECURED TO PREVENT WIND MILLING. IF THE OPERATING CONDITIONS OF THE FAN ARE TO BE CHANGED (SPEED, PRESSURE, TEMPERATURE, ETC.) CONSULT CINCINNATI FAN, OR OUR SALES OFFICE FOR YOUR TERRITORY, TO DETERMINE IF THE UNIT WILL OPERATE SAFELY AT THE NEW CONDITIONS.**

## A. Hardware:

All fan hardware should be checked to make sure it is tight. All set screws or taper-lock bushing bolts should be tightened to the torque values shown in **Tables 1 and 2** on page 4.

**NOTE:** If any set screws have become loose, they must be thrown away and replaced. **NEVER** use set screws more than once. **Replace with knurled, cup-point set screws with a nylon locking patch.**

## B. Motor and Fan Bearing Lubrication:

### 1. Motor Bearings:

Most smaller motors have sealed bearings that never require re-lubrication for the life of the motor. For any motors with grease fittings, consult the motor manufacturers recommendations with reference to the lubrication frequency and the type of grease that should be used.

**DO NOT** over grease the motor bearings. Generally, 1-2 shots should be enough. Use a hand operated grease gun at no more than 40 PSI. **IF POSSIBLE, CAREFULLY lubricate the motor bearings while the motor is running.**

## 2. Fan Bearings:

The fan bearings should be re-lubricated per the chart below and on the outside of the fan drum. Use this chart for all clean and dry applications where the fan airstream temperature is -20°F (-29°C) up to 200°F (93°C). This would be the correct temperature limits for Model **TAF** and **WAF** fans. Although the airstream temperature can be up to 200°F (93°C), the fan bearings (inside the bearing cover) will only be subjected to a maximum of 120°F (49°C).

For Models **HTF** and **HTF/WAF** fans, the maximum airstream temperature limit is 375°F (191°C). **A chart similar to the chart below will also specify that only Dow Corning DC-44 high temperature (silicone based) grease should be used.**

**DO NOT** overgrease the fan bearings. Generally, 1-2 shots should be enough. Use a hand-operated grease gun at no more than 40 PSI. **IF POSSIBLE, CAREFULLY LUBRICATE THE FAN BEARINGS WHILE THE FAN IS RUNNING.**

THIS FAN IS EQUIPPED WITH BEARINGS PRE-LUBRICATED AND READY FOR USE Generally Recommended Lubrication Frequency in MONTHS						
FAN OPERATING SPEED (RPM)	FAN SHAFT O.D. IN INCHES					
	1/2" TO 1"	1 1/8" TO 1 1/2"	1 5/8" TO 1 15/16"	2" TO 2 1/2"	2 11/16" TO 3 3/16"	3 7/16" TO 3 15/16"
UP TO 500	6	6	6	6	5	5
501-1000	6	6	6	5	4	4
1001-1500	6	5	5	4	3	2
1501-2000	5	5	4	3	2	1
2001-2500	5	5	3	2	2	—
2501-3000	5	4	2	2	1	—
3001-3500	4	3	2	1	—	—
3501-4000	3	3	1	—	—	—
4001-4500	2	2	1	—	—	—
4501-5000	2	1	—	—	—	—

The above lubrication frequencies are based on the fan bearings operating in a clean and dry environment from -20°F (-29°C) up to 120°F (49°C). For hostile, moisture laden environments and/or temperatures below -20°F (-29°C) or above 120°F (49°C), consult the bearing manufacturer for the proper grease type and recommended lubrication frequencies.

**If possible, carefully lubricate the bearings while the fan is running.**

Add grease until a slight bead appears at the bearing seals. **DO NOT** over grease. Generally, 1-2 shots with a hand grease gun that has a maximum pressure rating of 40 PSI.

**Warning:** Over greasing bearings will cause them to run hot.

The **TYPE** of grease you use **MUST BE** compatible with the grease already in the bearings.

## C. Propeller Balance:

All propellers are balanced at the factory. It is not uncommon that additional "trim balancing" is required after the fan is assembled. Trim balancing of the fan assembly, in the field, is typically always necessary for all replacement props.

Airstream material or chemicals can cause abrasion or corrosion of the fan parts. This wear is generally uneven and, over time, will lead to the prop becoming unbalanced causing excessive vibration. When that happens, the prop must be rebalanced or replaced. The other airstream components should also be inspected for wear or structural damage and cleaned or replaced if necessary. **After cleaning any prop, it should be balanced.**

There are two ways to balance a propeller:

### 1. Add balancing weights for fabricated aluminum, steel or stainless steel props:

Balance weights should be rigidly attached to the prop at a location that will not interfere with the fan housing nor disrupt air flow. They should (if at all possible) be welded to the prop. When trim balancing the propeller, on the fan shaft, be sure to ground the welder **directly** to the prop. Otherwise, the welding current will likely pass through the fan shaft and damage the fan and/or motor bearings.

### 2. Grinding off material for cast aluminum props:

When grinding on the prop to remove material, be very careful not to grind too much in one area. That could affect the structural integrity of the prop.

#### D. Vibration:

As mentioned previously in this manual, excessive vibration can cause premature motor and/or fan bearing failure that could lead to catastrophic failure of the fan. After performing any routine maintenance, the vibration readings should be taken again. New readings should be taken (maximum every 12 months) and compared to the readings you recorded previously. **If any major differences are present, the cause should be determined and corrected before the fan is put back into operation.**

The most common causes of vibration problems are:

1. Prop unbalance
2. Bearing failure
3. Mechanical looseness
4. Poor fan inlet and/or discharge conditions
5. Foundation stiffness
6. Misaligned sheaves and/or belts

#### E. Fan Shaft & Bearing Replacement:

The fan shaft and bearings for Cincinnati Fan **tube axial** fans are carefully selected to match the maximum load and operating conditions. If the instructions in this manual and those provided by the bearing manufacturer are followed, you should not need to replace the bearings for many years.

**When you do need to replace the bearings, the fan shaft should also be replaced.**

**Use the following applicable steps when replacing the fan shaft/bearing assembly:**

1. **LOCK OUT THE POWER SOURCE AND DISCONNECT THE POWER AT THE MOTOR CONDUIT BOX.**
2. Remove the entire fan/motor assembly from the duct work or machine.
3. Place fan on the floor or on a work bench, with the motor on top, and secure the fan so it cannot roll.
4. Measure the distance from the end of the fan shaft to the front of the propeller hub. **Keep this dimension for later.**
5. Loosen and remove the two (2) set screws in the propeller. They will have to be replaced.
6. Pull the propeller off of the fan shaft being careful not to deform the blades.
7. Loosen (**do not remove**) the four (4) "**locking bolts**" in the side of the motor adjustment base.
8. Turn (**do not remove**) the four(4) "**tensioning bolts**" in the top of the motor adjustment base counter-clockwise to loosen the tension on the belt(s).

##### **Step 9 for Models TAF and HTF only:**

Remove the screws in the bearing cover. Remove the bearing cover. On Model **HTF**, be careful when removing the cover so as not to tear the insulation fabric inside and underneath the cover.

**Proceed to STEP 12.**

##### **Step 9 for Models WAF and WAF-HTF only:**

Remove the caulking on the front of the moisture displacement collar and remove the set screw in the collar that holds the collar on the fan shaft.

##### **Step 10 for Models WAF and WAF-HTF only:**

Remove the 4 screws holding the cover over the fan shaft onto the bearing cover.

##### **Step 11 for Models WAF and WAF-HTF only:**

Carefully remove the bearing cover so as not to damage the gasket under the cover on Model **WAF**, or the insulation fabric inside and underneath the cover on Model **WAF-HTF**.

**Proceed to STEP 12.**

12. Slide the belt(s) off of the motor sheave and then the fan sheave.
13. Remove the belt(s) through the top of the belt tube.
14. Loosen the set screws, or the bolts in the taper-lock bushing, of the fan sheave and remove the sheave from the fan shaft.  
**NOTE: It should not be necessary to loosen or remove the motor sheave.**
15. Disconnect the grease fittings from the bearings being careful not to kink the grease lines.
16. Remove the bolts that hold the bearings onto the bearing base.
17. Remove the fan shaft and bearings as an assembly.
18. Measure the distance from both ends of the fan shaft to the bearings on each end. **Keep these dimensions for later.**
19. Properly dispose of the old shaft and bearings.
20. Install the new fan bearings onto the bearing base with the hardware removed in **STEP 16** above. **DO NOT** tighten at this time. Be sure the bearing locking collars are facing each other and the set screws are in line with each other.  
**NOTE: On Models HTF and WAF-HTF, there is an insulation fabric that covers the entire bearing mounting plate surface. The bearings are mounted on top of this fabric.**
21. Install the new fan shaft into the bearings so it extends out from both bearings per the dimensions you took in **STEP 18** above. Be sure the bearing locking collars are facing each other and the set screws are in line with each other.
22. Tighten the bearing mounting bolts that hold the bearings to the bearing base.
23. Using a soft-faced mallet, **GENTLY** tap on the shaft, in between the two bearings, while turning the shaft by hand. This will "**seat**" the bearing races. **The shaft must turn freely.**
24. Tighten the set screws in both bearings to the proper torque values shown in **Table 1** on page 4. **NOTE: If there are 2 set screws per bearing, make sure you tighten one set screw of one bearing in line with one set screw in the other bearing. Then tighten the other 2 set screws.**
25. Turn the fan shaft by hand again to make sure it turns freely and does not bind.

26. **Carefully** re-install the lubrication fittings into the bearings.
27. Install a new key into the keyway of the fan shaft for the fan sheave.
28. Replace the set screws in the fan sheave or the bolts in the fan sheave, taper-lock bushing.
29. Re-install the fan sheave onto the fan shaft and check the fan sheave alignment with the motor sheave. Both sheaves must be aligned as shown in **Fig. 2** on page 6.
30. After you have properly aligned the fan and motor sheaves, lock the set screws or the taper-lock bushing bolts in the fan sheave to the torque values shown in **Tables 1** or **2** on page 4.
31. Re-install the belt(s) onto the fan and motor sheaves.
32. Adjust the tension on the belt(s) by turning the 4 adjustment bolts on the top of the motor base. To obtain proper belt tension, refer to **Section H, V-Belt Drive Installation** on pages 5 and 6.

**Step 33 for Models TAF and HTF only:**

Re-install the bearing cover over the bearings, install the bolts and tighten them. On Model **HTF**, the insulation fabric **MUST** still be in place inside the bearing cover and on the bearing base surface where the bearings are mounted.

**Proceed to Step 37.**

**Step 33 for Model WAF only:**

Check the gasket on the bearing base, where the bearing cover will be mounted, to assure it is in good condition. If not, it **MUST** be replaced. Re-install the bearing cover over the bearings, install the bolts and tighten them.

**Step 34 for Model WAF only:**

Re-apply a small bead of silicone caulk on the back surface of the cover that you removed in **Step 10** on page 11.

Slide the cover over the fan shaft and mount it on the front of the bearing cover with the 4 screws.

**Step 35 for Model WAF only:**

Replace the set screw in the moisture displacement collar and then slide the collar over the fan shaft until it just clears the front of the bearing cover. Turn the fan shaft, by hand, to make sure the collar is not rubbing on the bearing cover.

**Step 36 for Model WAF only:**

Tighten the set screw in the collar onto the fan shaft to the appropriate torque value in **Table 1** on page 4.

Apply a bead of silicone caulk around the shaft on the front of the collar.

**Proceed to Step 37.**

**Step 33 for Model WAF-HTF only:**

Check to make sure the insulation fabric inside the bearing cover, and on the bearing base, is in good condition. If not, it **MUST** be replaced. Re-install the bearing cover over the bearings, install the bolts and tighten them.

**Step 34 for Model WAF-HTF only:**

Re-apply a small bead of silicone caulk on the back surface of the cover that you removed in **Step 10** on page 11.

Slide the cover over the fan shaft and mount it on the front of the bearing cover with the 4 screws.

**Step 35 for Model WAF-HTF only:**

Replace the set screw in the moisture displacement collar and then slide the collar over the fan shaft until it just clears the front of the bearing cover. Turn the fan shaft, by hand, to make sure the collar is not rubbing on the bearing cover.

**Step 36 for Model WAF-HTF only:**

Tighten the set screw in the collar onto the fan shaft to the appropriate torque value in **Table 1** on page 4.

Apply a bead of silicone caulk around the shaft on the front of the collar.

**Proceed to Step 37.**

37. Install new set screws in the propeller.
38. Install a new key in the fan shaft keyway for the propeller.
39. Install the propeller onto the fan shaft and locate the hub on the shaft to the same dimension you took in **Step 4** on page 11.
40. **Carefully** spin the propeller, by hand, and listen for any rubbing or grinding sounds. If any are heard, find the cause and make the necessary corrections.
41. Tighten the propeller set screws onto the fan shaft to the appropriate torque value in **Table 1** on page 4.  
**NOTE:** Tighten the set screw over the key first and then tighten the set screw onto the shaft.
42. Repeat **Step 40** above.
43. Re-install the fan into your duct work or onto your machine.
44. Reconnect the electrical wires to the motor.
45. **“Bump start”** the motor and then turn it off. Check the fan rotation as it slows down. If necessary, make wiring changes to correct the fan rotation. **NOTE:** This step should only be necessary on 3 Phase motors.
46. After running the fan for 3 days, **lock out and disconnect power to the motor** and remove fan from the duct system or machine.
47. Repeat **Step 7** on page 11 and then **Steps 34, 43, 44** and **45** above.

**F. Dampers and Shutters: (Airflow control device)**

Turn off and lock out power to the fan motor. Any dampers or shutters should be periodically inspected to make sure all parts are still operable within their full range and there is no interference with any other damper or fan components. Any bearings or seals should be checked for their proper function. The manufacturers maintenance instructions should be followed.

### **G. Safety Equipment & Accessories:**

It is the user's responsibility to make sure that all safety guards required by company, local, state and OSHA regulations are properly attached and fully functional at all times. If any guards become defective or non-functional at any time, **the power to the fan MUST be turned off and locked out** until complete repairs and/or replacements have been made, installed and inspected by authorized personnel. Any accessories used in conjunction with the fan should also be inspected to make sure they are functioning within their intended limits and design specifications. The manufacturer's maintenance manuals should be referred to for correct maintenance procedures. These accessories include, but are not limited to, the following:

Shaft seals, inspection doors, vibration isolators or vibration bases, air flow or pressure measuring equipment, hoods, controls, special coatings, silencers, expansion joints or flexible connectors, and filters.

### **VI. ORDERING REPLACEMENT PARTS:**

Under normal conditions, you should not need any spare or replacement parts for at least 24 months after shipment from Cincinnati Fan. That does not include any wear due to abrasion, corrosion, excessive temperatures, abuse, misuse, accident or any severe conditions the fan was not designed for.

- A. If this fan is vital to any process that could cost you lost revenue, we strongly recommend that you keep a fan propeller, shaft and bearing assembly, motor, sheaves and belt(s) at your location.**
- B. If this fan is vital for the safety of any people and/or animals, we strongly recommend that you keep a complete fan/motor assembly, as originally ordered, at your location.**

To order any parts or complete units, contact us for the name of our sales office for your area. Or you can find them on our website at: [www.cincinnati-fan.com](http://www.cincinnati-fan.com)

---

**WE MUST HAVE THE FAN SERIAL NUMBER FROM THE FAN NAME PLATE TO IDENTIFY PARTS CORRECTLY.**

---

## VII. TROUBLESHOOTING

Potential problems and causes listed below are in no order of importance or priority. The causes are only a list of the most common items to check to correct a problem. If you find the cause of a problem, **DO NOT** assume it is the **ONLY** cause of that problem. Different problems can have the same causes.

### DANGER

**Troubleshooting should only be performed by trained personnel. Any potential electrical problems should only be checked by a licensed electrician. All safety rules, regulations and procedures MUST be followed. Failure to follow proper procedures can cause property damage, severe bodily injury and death.**

PROBLEM	CAUSE
<b>Excessive Vibration</b>	<ol style="list-style-type: none"> <li>1. Loose mounting bolts, set screws or taper-lock hub bolts.</li> <li>2. Misalignment of motor shaft and fan shaft.</li> <li>3. Worn or corroded propeller.</li> <li>4. Accumulation of foreign material on propeller.</li> <li>5. Bent motor or fan shaft.</li> <li>6. Worn motor and/or fan bearings.</li> <li>7. Motor out of balance.</li> <li>8. Inadequate structural support.</li> <li>9. Support structure not sufficiently cross braced.</li> <li>10. Weak or resonant foundation.</li> </ol>
<b>Airflow (CFM) Too Low</b>	<ol style="list-style-type: none"> <li>1. Propeller turning in wrong direction (<b>rotation</b>).</li> <li>2. Actual system static pressure (<b>SP</b>) is higher than expected.</li> <li>3. Motor or fan speed (<b>RPM</b>) too low.</li> <li>4. Damper or shutter not adjusted properly.</li> <li>5. Leaks or obstructions in duct work.</li> <li>6. Filters dirty.</li> <li>7. Inlet and/or discharge guards are clogged.</li> <li>8. Duct elbow too close to fan inlet and/or discharge.</li> <li>9. Improperly designed duct work</li> </ol>
<b>Airflow (CFM) Too High</b>	<ol style="list-style-type: none"> <li>1. Actual system static pressure (<b>SP</b>) is lower than expected.</li> <li>2. Motor or fan speed (<b>RPM</b>) too high.</li> <li>3. Filter not in place.</li> <li>4. Damper or shutter not adjusted properly.</li> </ol>
<b>Motor Overheating</b>	<p><b>NOTE: A normal motor will operate at 174°F. See B-8 on page 7.</b></p> <ol style="list-style-type: none"> <li>1. Actual system static pressure (<b>SP</b>) is lower than expected.</li> <li>2. Voltage supplied to motor is too high or too low.</li> <li>3. Motor speed (<b>RPM</b>) too high or defective motor.</li> <li>4. Air density higher than expected.</li> <li>5. Motor wired incorrectly and/or loose wiring connections.</li> </ol>
<b>Excessive Noise</b>	<ol style="list-style-type: none"> <li>1. Propeller rubbing inside of housing.</li> <li>2. Worn or corroded propeller.</li> <li>3. Accumulation of foreign material on propeller.</li> <li>4. Loose mounting bolts, set screws or taper-lock hub bolts.</li> <li>5. Bent motor or fan shaft.</li> <li>6. Worn motor and/or fan bearings.</li> <li>7. Motor out of balance.</li> <li>8. Motor and/or fan bearings need lubrication.</li> <li>9. Vibration originating elsewhere in system.</li> <li>10. System resonance or pulsation.</li> <li>11. Inadequate or faulty design of fan support structure.</li> <li>12. Fan operating near “stall” condition due to incorrect system design or installation.</li> </ol>
<b>Fan Doesn't Operate</b>	<ol style="list-style-type: none"> <li>1. Motor wired incorrectly and/or loose wiring connections.</li> <li>2. Incorrect voltage supply.</li> <li>3. Defective fuses or circuit breakers.</li> <li>4. Power turned off elsewhere.</li> <li>6. Defective motor.</li> </ol>

**VIII. LONG TERM STORAGE INSTRUCTIONS: (Storage exceeding 30 days after receipt of equipment)**

**NOTE: Failure to adhere to these instructions voids all warranties in their entirety.**

1. Storage site selection:
  - (a) Level, well-drained, firm surface, in clean, dry and warm location. Minimum temperature of 50°F (10°C).
  - (b) Isolated from possibility of physical damage from construction vehicles, erection equipment, etc.
  - (c) Accessible for periodical inspection and maintenance.
2. The fan should be supported under each corner of its base to allow it to “breathe”. Supports (2 x 4’s, timbers, or rail-road ties) should be placed diagonally under each corner.
3. If the equipment is to be stored for more than three (3) months, the entire fan assembly must be loosely covered with plastic, **but not tightly wrapped**.
4. Initial inspections must be made of the fan components, and immediate corrective action taken if discrepancies are found, to insure adequate protection of the equipment during storage.
  - (a) Sheave center distance should be reduced to reduce tension on the belts.

5. Storage Maintenance:

***A periodic inspection and maintenance log, by date and action taken, must be developed and maintained for each fan. See example below. Each item must be checked monthly.***

**EXAMPLE:**

**Storage / Maintenance Schedule Log**

ITEM	ACTION	DATES CHECKED
1	Re-inspect units to insure any protective devices used are functioning properly. Check for scratches in the finish which will allow corrosion or rust to form.	
2	Rotate propeller a minimum of 10 full revolutions to keep the motor and fan bearing grease from separating and drying out. <b><i>This is a critical step.</i></b>	

6. General Motor Procedure:

If the motor is not put into service immediately, the motor must be stored in a clean, dry, warm location. Minimum temperature of 50°F. (10°C.). Several precautionary steps must be performed to avoid motor damage during storage.

- a. Use a “Megger” each month to ensure that integrity of the winding insulation has been maintained. Record the Megger readings. Immediately investigate any significant drop in insulation resistance.
- b. **DO NOT** lubricate the motor bearings during storage. Motor bearings are packed with grease at the factory. Excessive grease can damage the insulation quality in the motor.
- c. If the storage location is damp or humid, the motor windings **must** be protected from moisture. This can be done by applying power to the motor’s space heaters, (IF AVAILABLE) while the motor is in storage. If the motor does not have space heaters, storing it in a damp or humid location will, very quickly, cause internal corrosion and motor failure which is not warranted.
- d. Rotate motor shaft a minimum of 10 full turns each month to keep bearing grease from separating and drying out.

**NOTE:**

**For specific storage instructions, for the actual motor and any accessory parts that were supplied, refer to the manufacturer’s instructions.**

## **IX. LIMITED WARRANTY:**

Cincinnati Fan & Ventilator Company (Seller) warrants products of its own manufacture, against defects of material and workmanship under normal use and service for a period of eighteen (18) months from date of shipment or twelve (12) months from date of installation, whichever occurs first. This warranty does not apply to any of Seller's products or any part thereof which has been subject to extraordinary wear and tear, improper installation, accident, abuse, misuse, overloading, negligence or alteration. This warranty does not cover systems or materials not of Seller's manufacture. On products furnished by Seller, but manufactured by others, such as motors, Seller extends the same warranty as Seller received from the manufacturer thereof. Expenses incurred by Purchaser's in repairing or replacing any defective product will not be allowed except where authorized in writing and signed by an officer of the Seller.

The obligation of the Seller under this warranty shall be limited to repairing or replacing F.O.B. the Seller's plant, or allowing credit at Seller's option. **THIS WARRANTY IS EXPRESSLY IN LIEU OF ALL OTHER WARRANTIES EITHER EXPRESSED OR IMPLIED INCLUDING THE WARRANTIES OF MERCHANTABILITY AND FITNESS FOR A PARTICULAR PURPOSE AND OF ALL OTHER OBLIGATIONS AND LIABILITIES OF THE SELLER. THE PURCHASER ACKNOWLEDGES THAT NO OTHER REPRESENTATIONS WERE MADE TO PURCHASER OR RELIED UPON BY PURCHASER WITH RESPECT TO THE QUALITY OR FUNCTION OF THE PRODUCTS HEREIN SOLD.**

Removal of the Seller's nameplate or any generic fan nameplate containing the fan serial number voids all warranties, either written or implied. Failure to complete and document all the pre-startup and post startup checks and perform the suggested routine maintenance checks voids all warranties, either written or implied.

## **LIMITATION OF LIABILITY:**

Notice of any claim, including a claim for defect in material or workmanship, must be given to Seller in writing within 30 days after receipt of the equipment or other products. Seller reserves the right to inspect any alleged defect at Purchaser's facility before any claim can be allowed and before adjustment, credit, allowance replacement or return will be authorized. See **RETURNS** below. Seller's liability with respect to such defects will be limited to the replacement, free of charge, of parts returned at Purchaser's expense F.O.B. Seller's plant and found to be defective by the Seller.

**IN NO EVENT WILL SELLER BE LIABLE FOR SPECIAL, INDIRECT, INCIDENTAL OR CONSEQUENTIAL DAMAGES, WHETHER IN CONTACT, TORT, NEGLIGENCE, STRICT LIABILITY OR OTHERWISE, INCLUDING WITHOUT LIMITATION DAMAGES FOR INJURY TO PERSONS OR PROPERTY, LOST PROFITS OR REVENUE, LOST SALES OR LOSS OF USE OF ANY PRODUCT SOLD HEREUNDER. PURCHASER'S SOLE AND EXCLUSIVE REMEDY AGAINST SELLER WILL BE THE REPLACEMENT OF DEFECTIVE PARTS AS PROVIDED HEREIN OR REFUND OF THE PURCHASE PRICE FOR DEFECTIVE PRODUCTS, AT SELLER'S SOLE OPTION. SELLER'S LIABILITY ON ANY CLAIM, WHETHER IN CONTRACT, TORT, NEGLIGENCE, STRICT LIABILITY OR OTHERWISE, FOR ANY LOSS OR DAMAGE ARISING OUT OF OR IN CONNECTION WITH PURCHASER'S ORDER OR THE PRODUCTS OR EQUIPMENT PURCHASED HEREUNDER, SHALL IN NO CASE EXCEED THE PURCHASE PRICE OF THE EQUIPMENT GIVING RISE TO THE CLAIM.**

## **RESPONSIBILITY:**

It is the understanding of the Seller that Purchaser and/or User will use this equipment in conjunction with additional equipment or accessories to comply with all Federal, State and local regulations. The Seller assumes no responsibility for the Purchaser's and/or User's compliance with any Federal, State and local regulations.

## **RETURNS:**

Cincinnati Fan & Ventilator Company assumes no responsibility for any material returned to our plant without our permission. An **RMA** (Return Material Authorization) number must be obtained and clearly shown on the outside of the carton or crate and on a packing slip. Any items returned must be shipped freight prepaid. Failure to comply will result in refusal of the shipment at our receiving department.

### **DISCLAIMER**

This manual, and all its content herein, is based on all applicable known material at the time this manual was created. **Any parts of this manual are subject to change at any time and without notice.**

If any statements, diagrams and/or instructions contained herein, **for components not manufactured by the Seller**, conflict with instructions in the manufacturer's manual (i.e.: motors, bearings, belts and sheaves, dampers, etc.), the instructions in the manufacturer's manual, for that component take precedent.

Should you want the latest version of this manual, please contact us or our sales office for your area. Or, you can print a current version by going to our website at: [www.cincinnati-fan.com](http://www.cincinnati-fan.com)



7697 Snider Road, Mason, OH 45040-9135  
Phone: (513) 573-0600 Fax: (513) 573-0640  
E-Mail: [sales@cincinnati-fan.com](mailto:sales@cincinnati-fan.com)



**X. PARTS DRAWING:**

**PLEASE NOTE**

Cincinnati Fan manufactures many models and arrangements with special variations. For that reason, the maintenance manuals contained on our website do not include a parts drawing nor the completed blower or fan specifications on page 1. For the parts drawing of all the standard components and specifications for the specific blower or fan that you have, please contact our local Cincinnati Fan sales office for your area.

You will need to give them the serial number shown on the blower or fan nameplate so they can supply you the correct information.

Click on "**Contact a Sales Rep**" on our website for the name and contact information for our local sales office for your area. **[www.cincinnati-fan.com](http://www.cincinnati-fan.com)**